



carina™
gardner

COQUETTE™ QUILT

www.carinagardner.com

fabrics shown from Carina Gardner's Coquette™ for Northcott

patterns

Coquette™ Quilt

Fabric designed by Carina Gardner
 Quilt designed by Carina Gardner
 Quilt Skill Level: Beginning to Intermediate
 Finished Size: 86" x 94" (Queen Size)

BLOCK SIZES

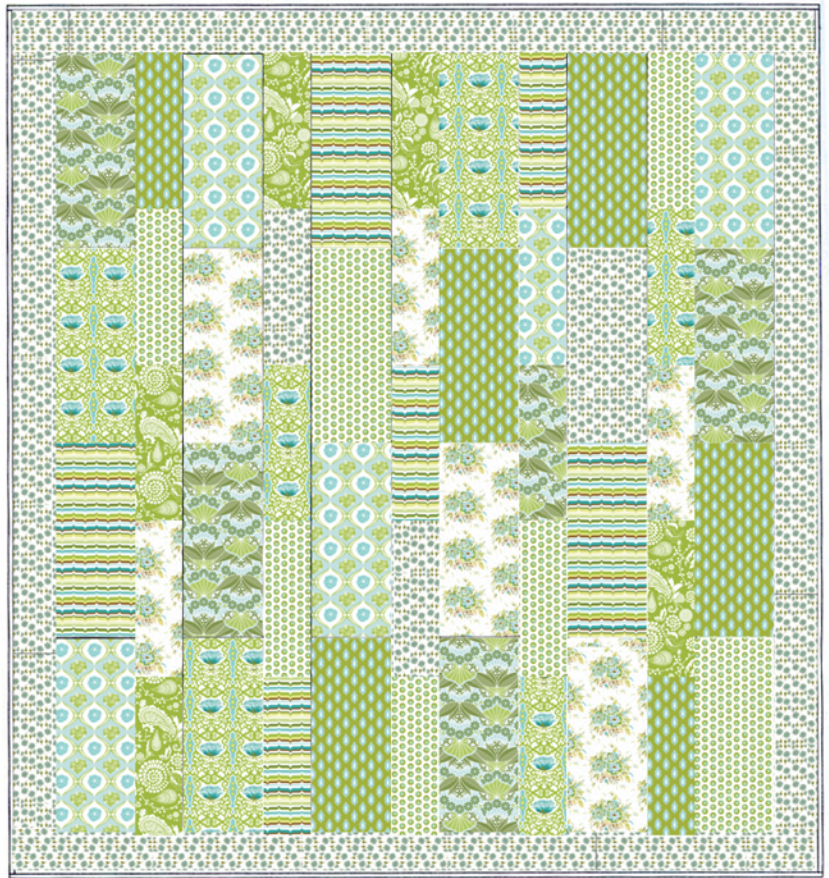
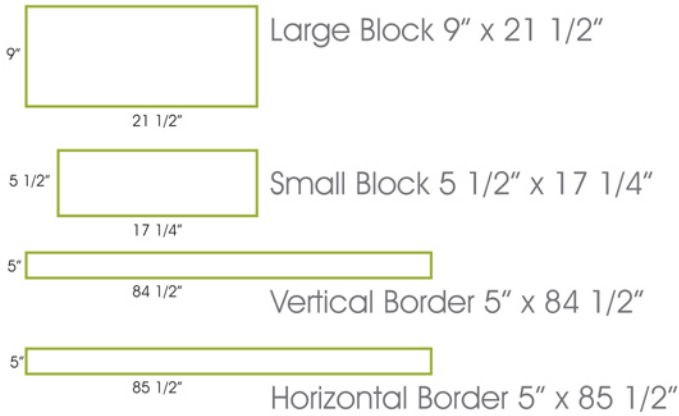

* Blocks & Borders includes 1/4" seam allowance

YARDAGE

* Yardage shown here allows for blocks to be placed vertical. Less fabric is needed if placed both vertical and horizontal.

fabric	large block	small block	yardage
Bouquet (T)	3	3	1 1/2 y
Paisley in Moss (P)		5	1/2 y
Triple Dot in Moss (D)	2	5	1 1/3 y
Gardenette (G)	4	1	2/3 y
Budding (B)	3	3	1 1/3 y
Stripe (S)	3	3	1 1/3 y
Primrose (R)	4	1	2/3 y
Leafette (L)	4	2	1 1/3 y
Blossom (M)	1	2	2/3 y

border		yardage
Blossom (M)	8 strips of 5" width and 44" lengths	1 1/3 y

binding		yardage
Gardenette (G)		1 1/2 y

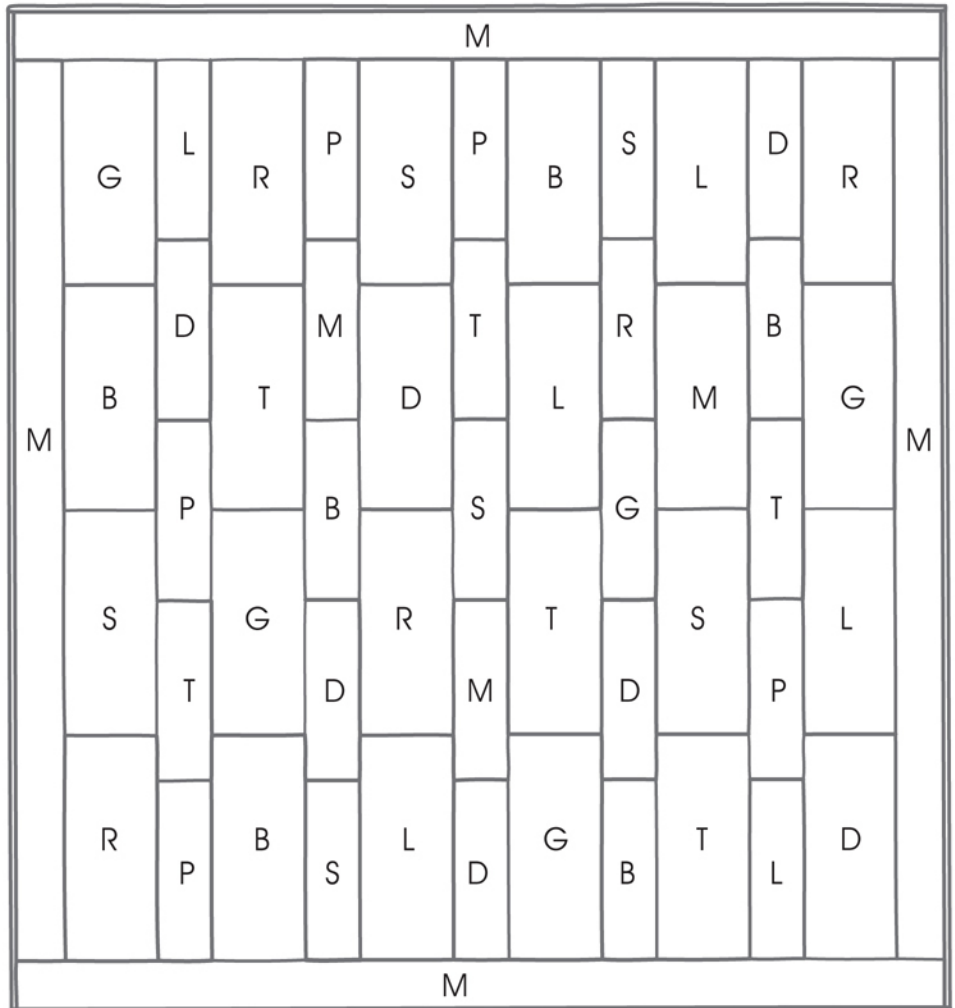

Coquette™ Quilt

TOOLS

- Ruler/rotary ruler and/or yardstick
- Scissors and/or rotary cutter and mat
- Hand-sewing needle
- Iron

CUTTING THE FABRIC

Fit the blocks vertically on the fabric.
Gardenette Example (4 Large Blocks + 1 Small Block)

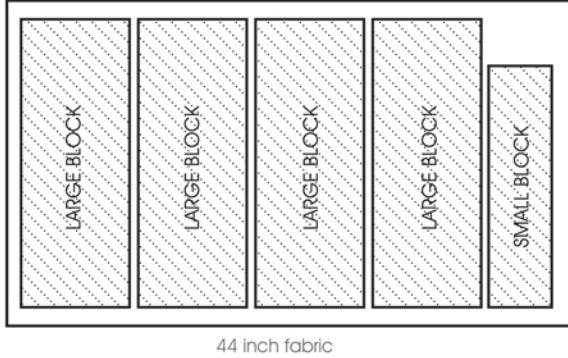

Leafette Example (4 Large Blocks + 2 Small Blocks)

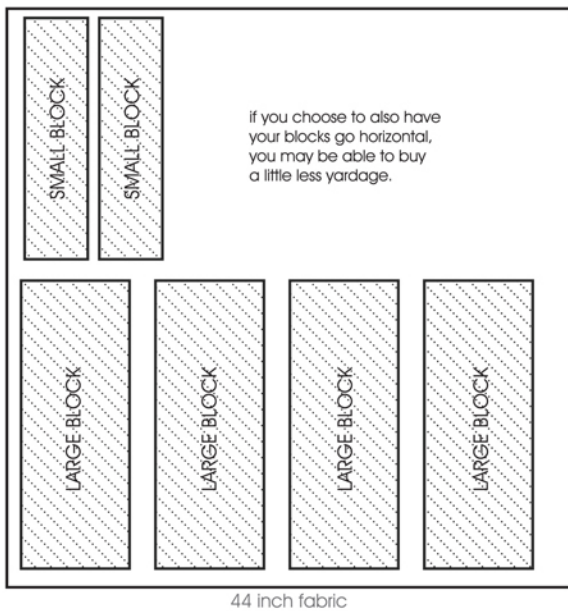

PUT TOGETHER BACK OF QUILT

The back of the quilt needs to be 4" longer on every side to be machine quilted (approximately 92" x 100" or about 6 1/2 yards of fabric). This may require sewing an extra piece of fabric in the center.



* includes 1/4 allowance

ASSEMBLING THE QUILT

Layout all of the blocks on a flat surface using the map on the first page.

Sew together blocks to create long vertical strips by placing RIGHT sides together. Then sew the vertical strips together.

1) sew wrong sides together horizontally

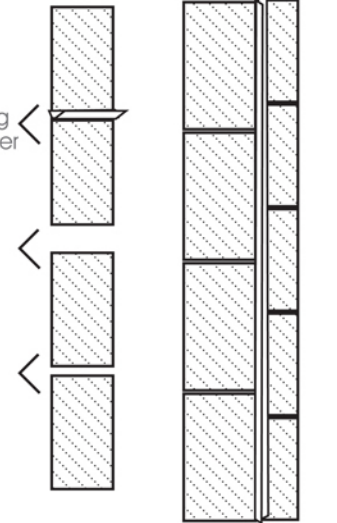

HOW TO CUT BIAS STRIPS FOR BINDING

Open your fabric. Lay it RIGHT side up. Fold one corner RIGHT sides together matching one selvage edge to make a triangle and press the edge. Open the fabric and cut along the creased edge.



Measure and mark 2 1/2" from each end of the cut edge. Continue to cut strips by measuring out 2 1/2" evenly along the original cut.

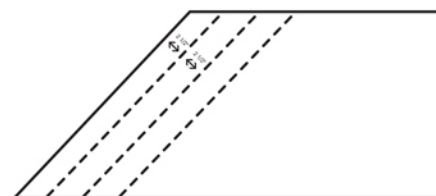

Coquette™ Quilt

ATTACH BORDER TO PATCHWORK FRONT

Square off patchwork by measuring each side. Ease your borders to get the same length on each side.

Attach vertical borders.

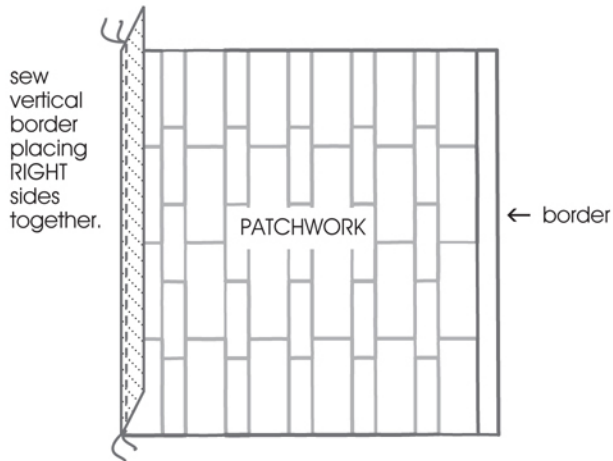

Attach the horizontal border pieces to finish off the front of the quilt.

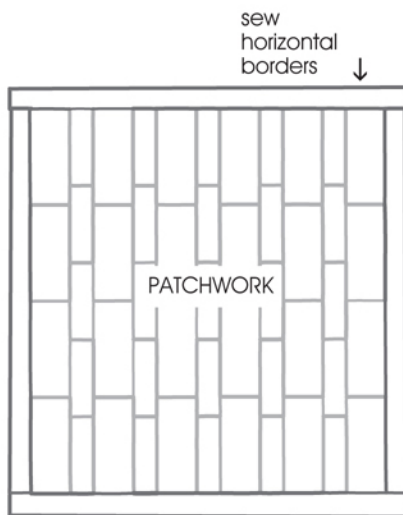

MACHINE QUILTING

Use a walking foot to quilt together batting, front, and back of quilt OR send to a machine quilter and prepare binding strips.

PREPARE BINDING

Join the bias strips into one continuous piece by placing the end of the strips perpendicular to each other with the RIGHT sides together. Stitch across the diagonal edges. Trim the edges. Continue to sew together strips until you have a piece measuring at least 345" long.

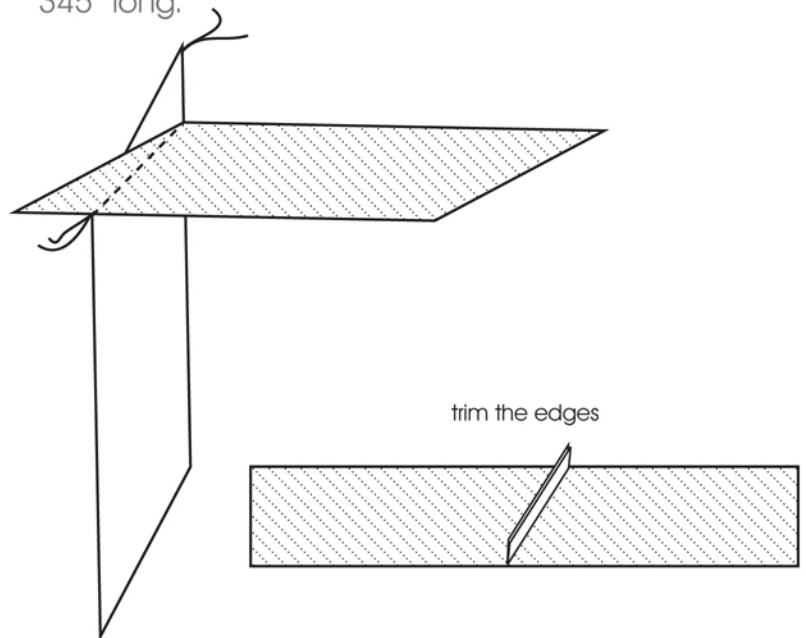

ATTACH BINDING

Fold the bias strips in half. Match the raw edge of the bias strip with the raw edge of the quilt.

Sew together the bias strip to the front of the quilt.

Close with a perfect bind.

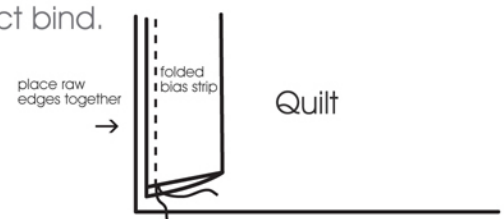

Hand-sew the binding to the back of the quilt.

